



IMAGININGS



Front Cover:
Metropolitan State Hospital
Norwalk, California

Medium Ironspot #77, Dark Ironspot;
Modular Brick; Velour Texture



TABLE OF CONTENTS

Introduction	2
Face Brick	3
Special Shapes	5
Residential Brick	6
Pavers	7
Thin Brick	9
Tile	11
Pool Coping	13
Brick Murals	14



Lucas Oil Stadium – Indianapolis, Indiana
Medium Ironspot #77 (Field), Manganese Ironspot (Accent)
Thin Brick Precast; 1/2" x 3-5/8" x 7-5/8" (Utility)
Velour Texture



Carmel Clay Public Library – Carmel, Indiana
Desert Ironspot Light, Desert Ironspot Dark, Manganese Ironspot; Roman, Modular; Velour Texture



Library – Tilden, Nebraska
Hand-Crafted Murals

IN PARTNERSHIP WITH THE IMAGINATION

Endicott products serve as the building blocks of the imagination. Giving life to ideas, bringing beauty and functionality to form and raising the level of craftsmanship to new heights. A partnership in the truest sense, Endicott enhances the imaginations of great architects and helps them realize their dreams.

The uniqueness, versatility and quality of Endicott products are legendary for their ability to amplify the design and give shape to the vision. Endicott prides itself on providing designers and builders with a product palette unequaled in the industry.

Available in a myriad of shapes, textures and dazzling colors, Endicott products are nationally recognized for their unmatched elegance and design versatility. Endicott has the raw materials and manufacturing facilities to fire the finest architectural products. You have the imagination. A partnership is in the making.



FACE BRICK

Endicott has a face brick to meet most any design criteria. A variety of colors, including authentic Ironspots and a wide selection of textures and sizes, provides the designer with an array of product selections.

SIZES & SPECIFICATIONS

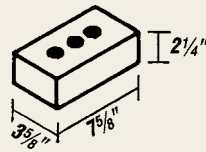

MODULAR

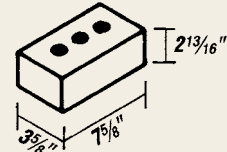

ENGINEER MODULAR

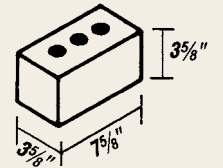

**CLOSURE
(Economy Modular)**

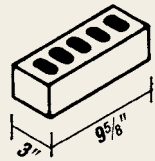

KINGSIZE

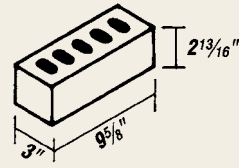

ENGINEER KINGSIZE

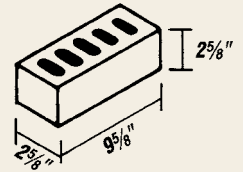

SLIMKING

University of Pennsylvania, Wharton School of Business – Philadelphia, Pennsylvania
Burgundy Blend; Normans - Shapes; Smooth Texture

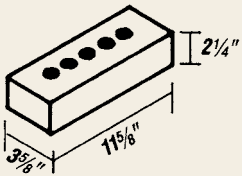

NORMAN

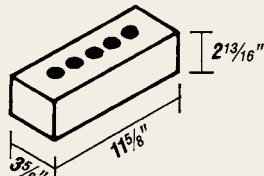

**NORWEGIAN
(Engineer Norman)**

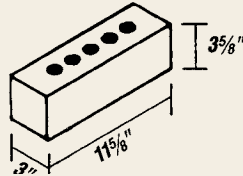

**3" UTILITY
(3" Bed Economy Norman)**

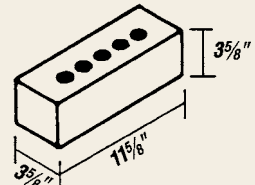

**UTILITY
(Economy Norman)**

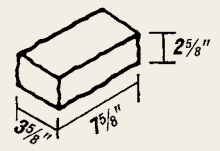

**DANISH
HAND MOULD**

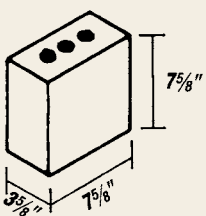

TRIPLE BRICK

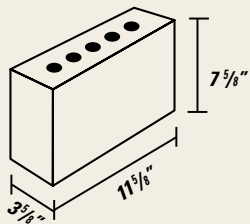

DOUBLE UTILITY

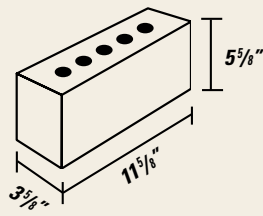

GIANT NORMAN

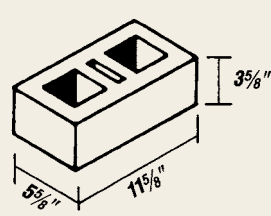

6" THRU WALL UNIT

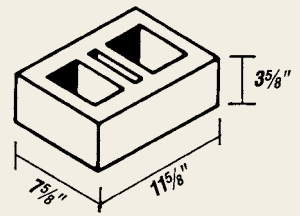

8" THRU WALL UNIT

TEXTURES

SHOWN HERE

- Antique
- Heritage
- Velour
- Artisan
- Smooth
- Velvetex

NOT SHOWN HERE, BUT AVAILABLE

- Danish Hand Mould
- Matt
- Vertical Score

FACE BRICK COLORS

Endicott provides a wide variety of face brick colors, textures and sizes. Contact us for a complete selection of products, or for your nearest distributor. You can also find selection information at endicott.com.



MANGANESE IRONSPOT – SMOOTH TEXTURE



SAHARA SANDS – HERITAGE TEXTURE



COPPERTONE – VELOUR TEXTURE



MEDIUM IRONSPOT #77 – ARTISAN TEXTURE



MERLOT SANDS – ANTIQUE TEXTURE



EXECUTIVE IRONSPOT – VELOUR TEXTURE



AUTUMN SANDS – HERITAGE TEXTURE



DESERT IRONSPOT (LIGHT) – VELOUR TEXTURE



DARK IRONSPOT – SMOOTH TEXTURE



BURGUNDY SANDS – HERITAGE TEXTURE



MEDIUM IRONSPOT #46 – VELVETEX TEXTURE



All Saints Catholic Church – Lakeville, Minnesota
Desert Ironspot Light; Utility - Shapes; Artisan Texture



SPECIAL SHAPES

Regardless of what's perceived in the mind's eye, Endicott possesses the ability to transform that image into an aesthetically beautiful shape of the highest quality. These shapes, available in colors, textures and sizes to match the face brick, create the benchmark for design flexibility.



Creekside Middle School – Carmel, Indiana
Medium Ironspot #46; Golden Buff;
Modular - Triple Brick - Shapes; Velour Texture





Private Residence – Lincoln, Nebraska
Burgundy Sands; Heritage Texture

RESIDENTIAL BRICK

Available in a myriad of colors, enhanced by a choice of accent textures, Endicott brick graces many outstanding residential projects throughout the United States.



Private Residence – Lincoln, Nebraska
Grey Heritage; Modular



Private Residence – Sioux Falls, South Dakota
Burgundy Sands; Heritage Texture; Modular

PAVERS

Endicott's complete line of brick pavers gracefully enhances any landscape setting and coordinates with Endicott's face brick, tile and pool coping.

Endicott's relieved edge pavers feature beveled edges that make a unique visual presentation. The pavers are set hand-tight or butt joint. Beveled edges create a spaced joint effect, yet are not grouted. Small spacings (1/16"-1/8") between units accommodate sand sweepings to keep the units apart and create interlock. They're manufactured to meet ASTM C902, Class SX, Type I, Application PX or ASTM C1272, Type R, Application PX specifications.



Independence Grove Forest Preserve – Libertyville, Illinois
Custom blend of paver colors and sizes

SIZES & SPECIFICATIONS

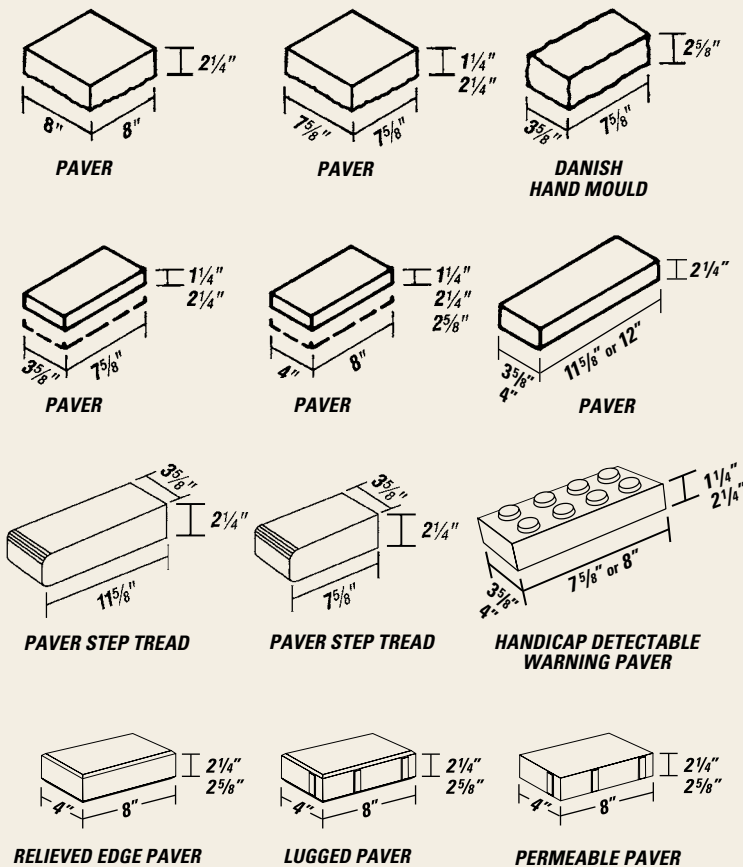

PAVER SPACERS

ELIMINATE PAVER CHIPPING PROBLEMS

Create and assure the needed spacing between pavers to avoid expensive and unsightly chipping. Keep the crisp appearance of square edge pavers!

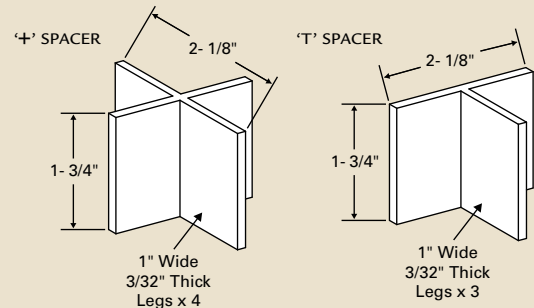

Handicap Detectable Warning Pavers

Consult the American Disabilities Act of 1990 Accessibility Guidelines for exact requirements and usage.



PAVERS (ALL PAVERS ARE WIRECUT TEXTURE)



MANGANESE IRONSPOT



MEDIUM IRONSPOT #77



MEDIUM IRONSPOT #46



COPPERTONE



BORDEAUX BLEND



DARK IRONSPOT



ROSE BLEND



RED BLEND



South Dakota State University – Brookings, South Dakota
 Special Blend; Thin Brick Precast; 1/2" x 2-1/4" x 7-5/8"; Wirecut Texture

Meets or exceeds the requirements of ASTM-C1088 specifications.

THIN BRICK

Endicott thin brick is ideally suited to year-round commercial, residential and remodeling applications. Genuine kiln-fired thin brick possesses the durability and unparalleled elegance of Endicott face brick, yet maximizes space and weighs considerably less.

There are a number of prefabricated panel systems available to the industry that can receive the thin brick

as factory or job site applied. Reputable installation suppliers have literature that you may obtain for review regarding project applicability.

Endicott thin brick may be applied over any structurally sound substrate. And because no footings or supports are required, thin brick may extend all the way to grade.

SIZES & TRIM UNITS



Endicott's unique "keyback" design mechanically locks thin brick into the concrete for maximum durability and permanence.

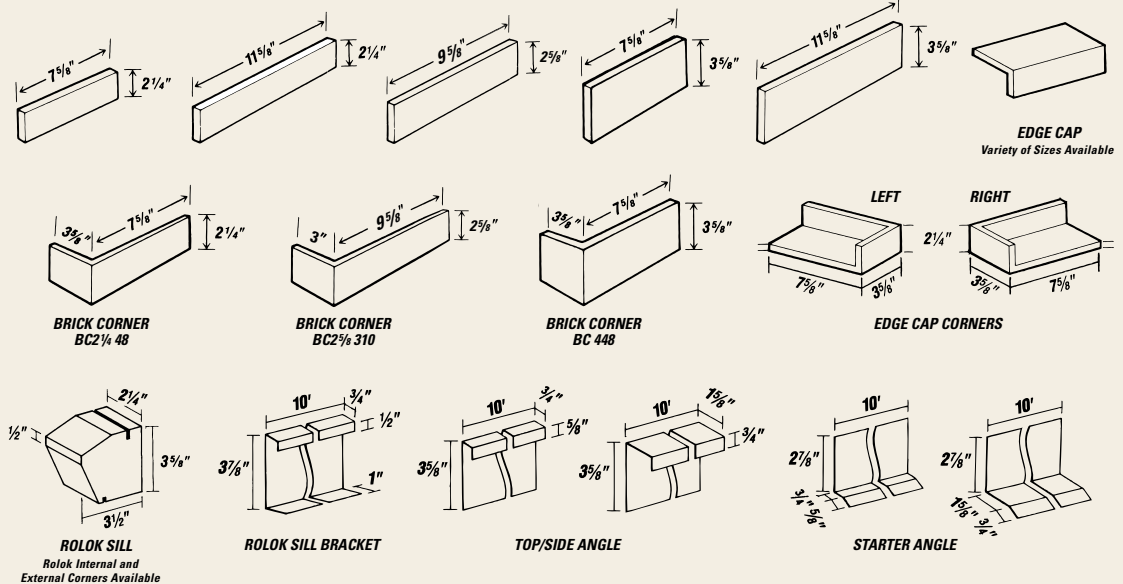

TEXTURES

SHOWN HERE

NOT SHOWN HERE, BUT AVAILABLE

Heritage Smooth
 Velour Wirecut

Stonetex

THIN BRICK COLORS

Endicott provides a wide variety of thin brick colors, textures and sizes. Contact us for a complete selection of products, or for your nearest distributor. You can also find selection information at endicott.com.



AUTUMN SANDS – HERITAGE TEXTURE

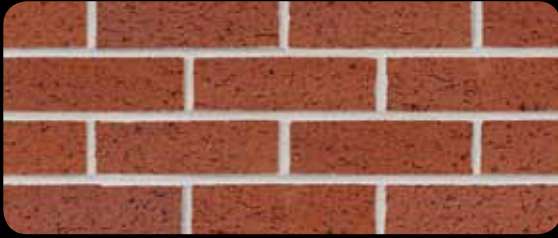

RED BLEND – VELOUR TEXTURE



LIGHT SANDSTONE – SMOOTH TEXTURE



DESERT IRONSPOT LIGHT – VELOUR TEXTURE



EXECUTIVE IRONSPOT – SMOOTH TEXTURE



BURGUNDY SANDS – HERITAGE TEXTURE



GOLDEN BUFF – WIRECUT TEXTURE



COPPERTONE – VELOUR TEXTURE



GREY BLEND – VELOUR TEXTURE



MEDIUM IRONSPOT #46 – WIRECUT TEXTURE



MANGANESE IRONSPOT – WIRECUT TEXTURE

TILE

Endicott's line of tile products is manufactured utilizing the same raw materials as thin brick, face brick and pavers. Thus, product coordination provides excellent design flexibility. The tile and trim units pictured below are available in a variety of colors and these textures – Smooth, Wirecut and Stonetex.

SIZES & SPECIFICATIONS

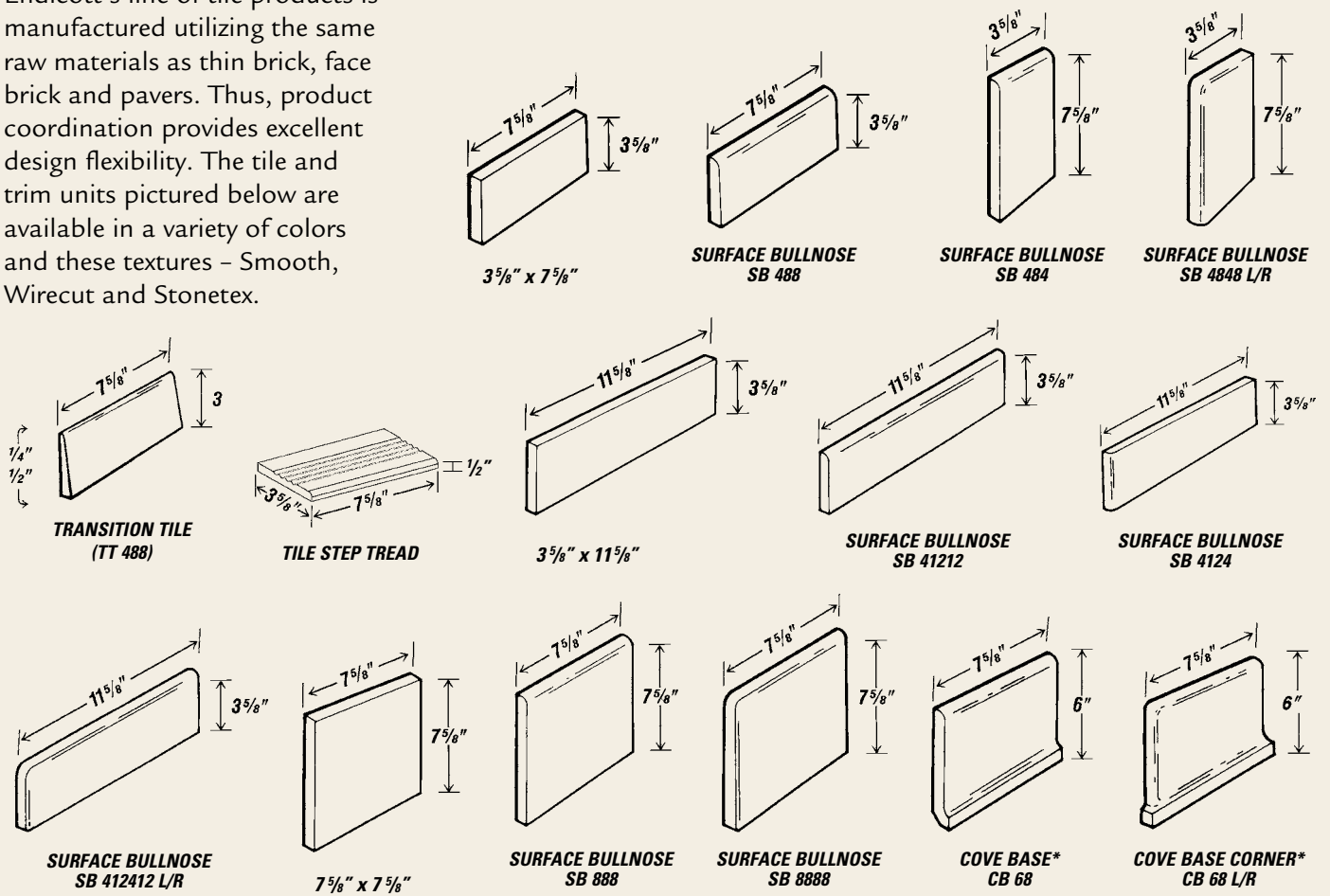

*Cove Base units are available in smooth texture only.



Church – St. Paul, Minnesota
Coppertone Smooth – $1\frac{1}{2}" \times 3\text{-}5\text{/}8" \times 7\text{-}5\text{/}8"$



Fashion Valley Mall – San Diego, California
Rose Blend Wirecut – $1\frac{1}{2}" \times 3\text{-}5\text{/}8" \times 7\text{-}5\text{/}8"$
and Dark Ironspot Wirecut – $1\frac{1}{2}" \times 3\text{-}5\text{/}8" \times 7\text{-}5\text{/}8"$

TILE COLORS (ALL SAMPLES SHOWN HERE ARE SMOOTH TEXTURE)



COPPERTONE

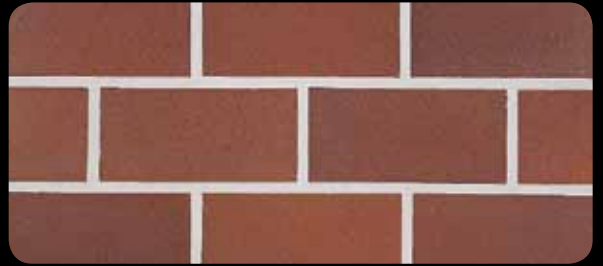

MEDIUM IRONSPOT #77



MEDIUM IRONSPOT #46



DESERT IRONSPOT



MANGANESE IRONSPOT



RED BLEND



ROSE BLEND



DARK IRONSPOT

TILE TEXTURES AVAILABLE *



SMOOTH TEXTURE

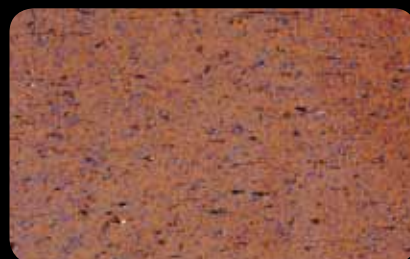

WIRECUT TEXTURE



STONETEX TEXTURE

POOL COPING

Applications for this unit are limited only by the imagination. In addition to swimming pools, other unique applications include step nosing and decorative accents on windows, fireplace mantels and hearths.

Pool coping units are available in colors to coordinate with Endicott pavers and tile.



ESTIMATING DATA

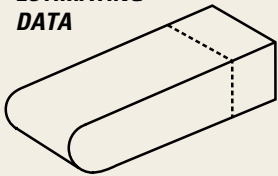

POOL COPING:

actual size – 2 1/4" x 3 5/8" x 9"
metric size – 57 x 92 x 228
weight per unit – 6#
no. per linear ft. – 3

actual size – 2 1/4" x 3 5/8" x 11 5/8"
metric size – 57 x 92 x 295
weight per unit – 7.5#
no. per linear ft. – 3

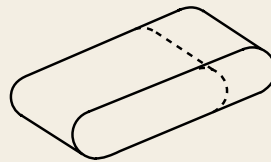

POOL COPING DOUBLE BULLNOSE:

actual size – 2 1/4" x 3 5/8" x 9"
metric size – 57 x 92 x 228
weight per unit – 6#
no. per linear ft. – 3

actual size – 2 1/4" x 3 5/8" x 11 5/8"
metric size – 57 x 92 x 295
weight per unit – 7.5#
no. per linear ft. – 3





First Community Bank – Reedsburg, Wisconsin



National Eagle Center – Wabasha, Minnesota



Private Residence – Fairbury, Nebraska

BRICK MURALS

Imagine the majesty of hand-crafted brick murals that capture the energetic vitality of life itself, all reproduced in authentic Ironspot colors that defy description. With visionary flair, Endicott continues to sculpt a reputation for producing works of art that are truly distinctive.



Endicott Clay Products Co and Endicott Tile LLC – Endicott, Nebraska



Endicott has been building one success story after another all across the U.S.

The unique clays found only in Jefferson County, Nebraska, make it possible for Endicott to produce a wide variety of face brick, pavers, tile, thin brick and special shapes that are nationally recognized for their quality and aesthetic beauty.

Endicott products are distributed throughout the United States. For literature, samples and the name of your nearest distributor, contact Endicott today.

Endicott Clay Products Co
P.O. Box 17
Fairbury, Nebraska USA 68352
402/729-3315 FAX: 402/729-5804

Endicott Tile LLC
P.O. Box 645
Fairbury, Nebraska USA 68352
402/729-3323 FAX: 402/729-5804

endicott@endicott.com
endicott.com

View Endicott Colors Now!

